

SPECIFICATIONS

1. 4" inlet/outlet.
2. Liquid capacity: 57 Gallons.
3. Solids capacity: 25 Gallons.
4. Unit weight w/std. covers: 198 lbs.
5. Maximum operating temperature 140°F continuous.
6. H2O rated cast iron grate.

NOTES

1. For gravity drainage applications only. Do not use for pressure applications.
2. 3/8" thick seamless polyethylene tank.
3. Unit supplied with built-in adapter for up to 2-1/2" of adjustability. Additional riser(s) available for deeper burial depth.
4. Cover placement allows full access to tank for proper maintenance.
5. Designed narrow footprint allows clearance through doorways and down stairwells.
6. Diffuser is removable to inspect or clean piping.
7. For buried applications.

ENGINEER SPECIFICATION GUIDE

Striem Settler™ catch basin model CB-50-G shall be lifetime guaranteed and made in USA of seamless, rotationally-molded Medium Density Polyethylene with a minimum 3/8" uniform wall thickness. Catch basin shall be furnished for below grade installation with cast iron H2O rated grated cover. Catch basin shall be provided with outlet and inlet connection.

THIRD PARTY STRUCTURAL ANALYSIS

The CB-50-G has been structurally analyzed in accordance with the requirements of IBC 2012 and ASCE/SEI 7 for direct burial. The maximum burial depth and backfill material are specified in our installation instructions. The structural design has been reviewed and sealed by a professional engineer registered in the state of California. A sealed structural analysis report is available upon request.

OPTIONS

- 3P:** 3" Plain end inlet / outlet
- 3M:** 3" Male thread inlet / outlet
- 4M:** 4" Male thread inlet / outlet
- BCB-7:** 7 gallon capacity sediment basket
- HDK-2:** High Water Anchor Kit

TeleGlide RISER OPTIONS

Included: 0" - 2-1/2"

- SR24:** 5" - 24"
- LR24:** 24" - 39"

*If in the range of 2-1/2"-5", contact Striem for a custom solution.

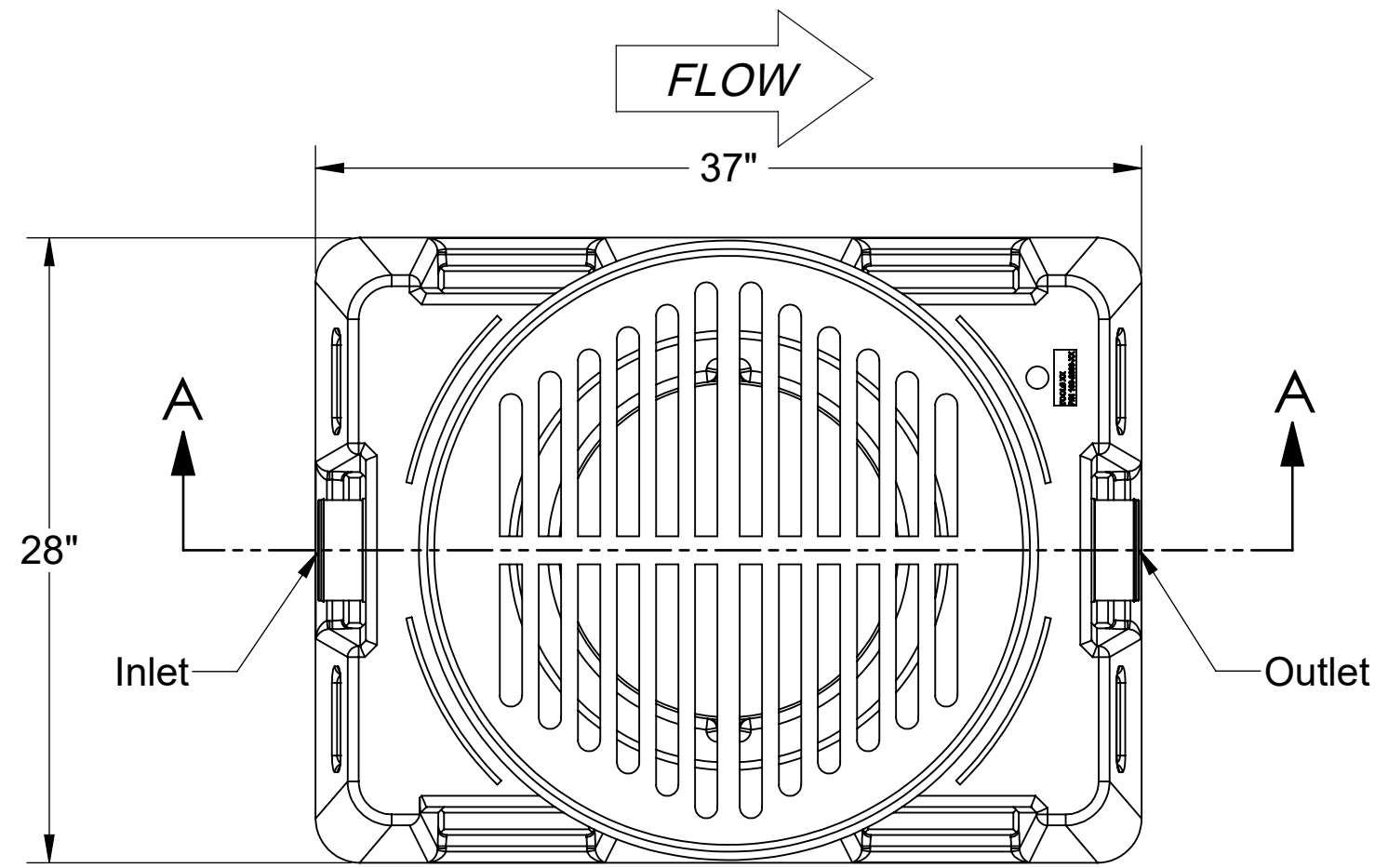

TOP VIEW

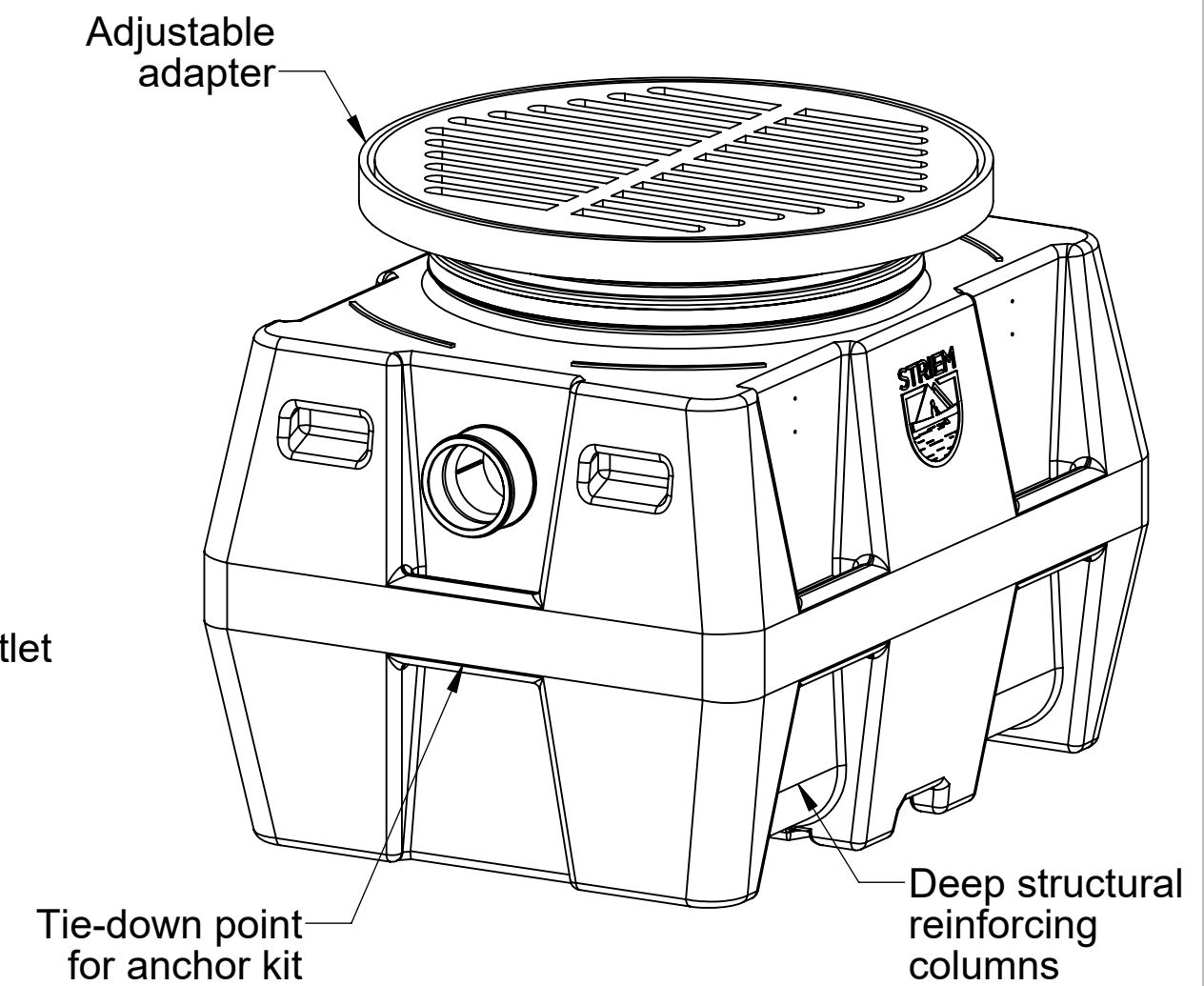

ISOMETRIC VIEW

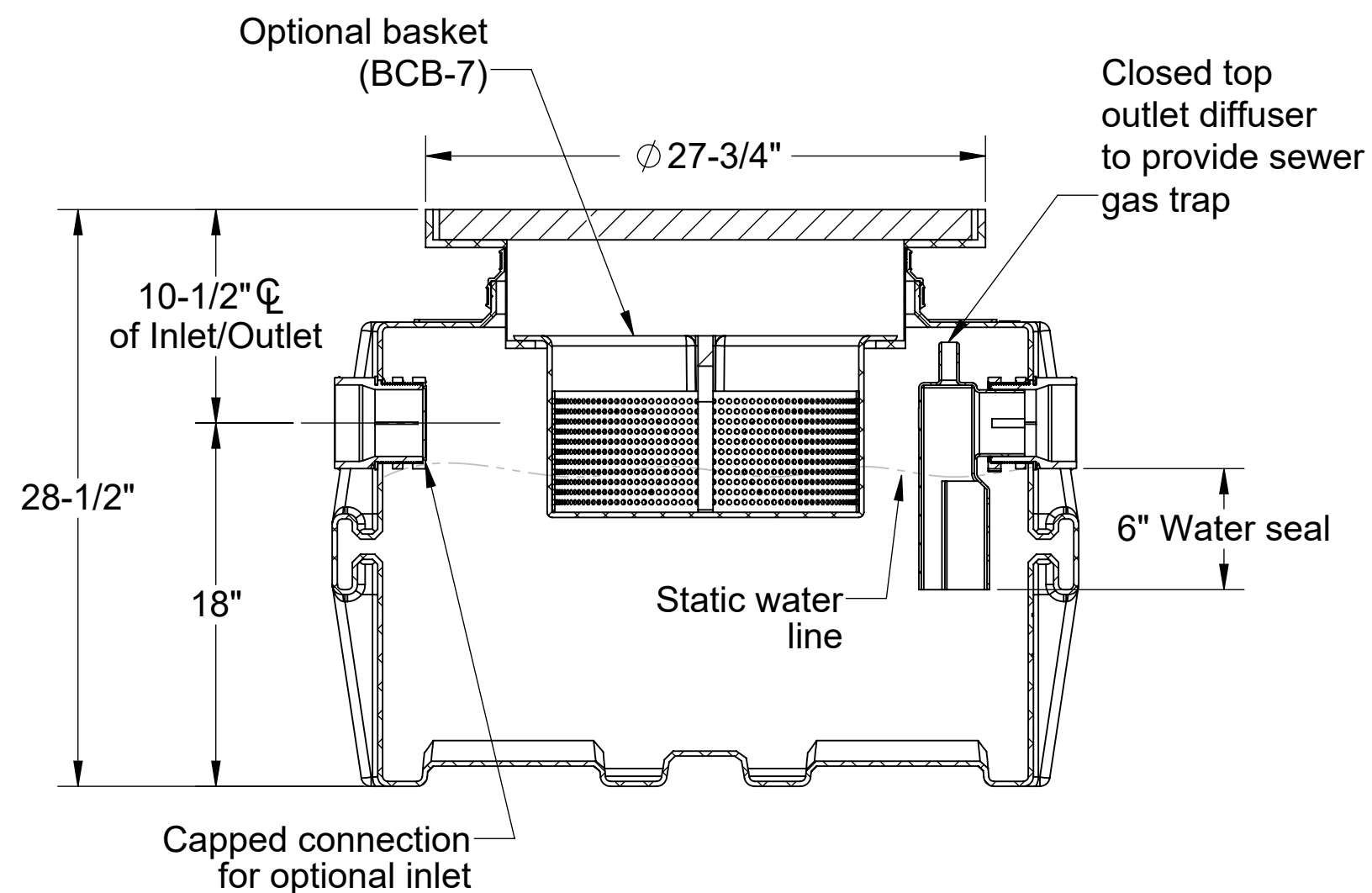

SECTION "A-A"

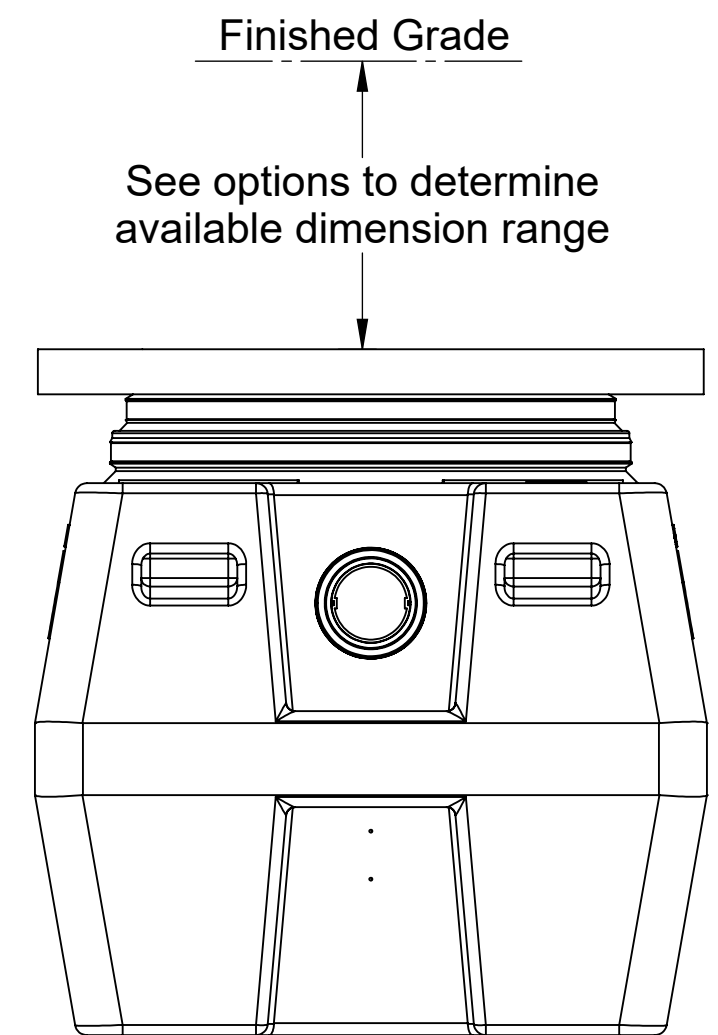

OUTLET END VIEW

MODEL NUMBER:	CB-50-G
DESCRIPTION:	SETTLER SERIES POLYETHYLENE CATCH BASIN WITH HIGHWAY RATED CAST IRON GRATE
DWG BY:	WLF
DATE:	3/10/22
REV:	0
ECO:	

SPECIFICATION SHEET

Striem
3100 Brinkerhoff
Kansas City, KS 66115
Tel: 913-222-1500
orders@striemco.com
www.striemco.com

Made in the U.S.A

PROPRIETARY AND CONFIDENTIAL

THE INFORMATION CONTAINED IN THIS DRAWING IS THE SOLE PROPERTY OF STRIEM, LLC. ANY REPRODUCTION IN PART OR AS A WHOLE WITHOUT THE WRITTEN PERMISSION OF STRIEM, LLC. IS PROHIBITED.